



*Serie pensata in grande ... liscia come una saponetta.*  
*A range planned in a big way, ... as smooth as a bar of soap.*



35505

gruppo monoforo per lavabo.  
*single hole washbasin mixer.*

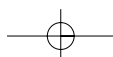

*Le dimensioni sono perfette,  
armonia ed equilibrio garantiti.*

*The dimensions are perfect, harmony  
and balance are guaranteed.*



35536

batteria lavabo a tre fori a parete  
con piastra.

*three-holes wall-up washbasin  
mixer with plate.*





*Cuori in comune.  
Se colpirà il cuore saranno soddisfazioni.*

*Hearts in common,  
If it hits the heart there will be satisfactions.*

## 35802

gruppo per doccia esterno.  
*wall-up shower mixer.*

## AC10067

colonna doccia con deviatore automatico, soffione snodato e doccia.

*rigid riser with automatic diverter,  
jointed shower head and handshower.*

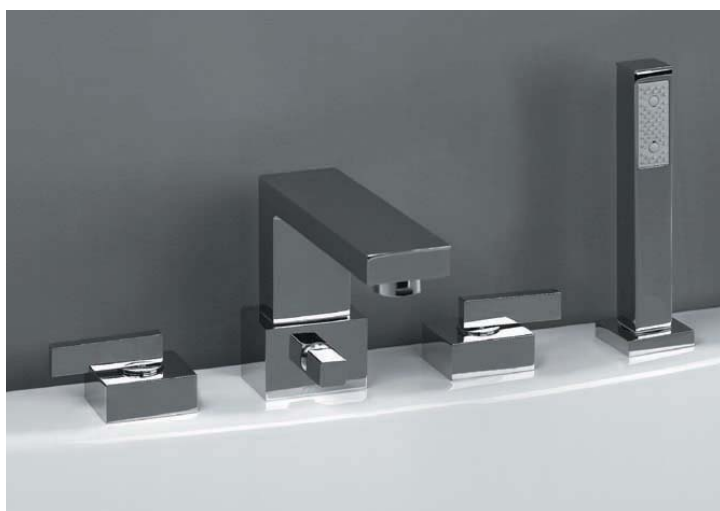

## 35025

bocca bordo vasca a quattro fori.

Four holes bathtub spout.

35505

gruppo monoforo per lavabo,  
finitura acciaio.

*single hole washbasin mixer,  
stainless steel finish.*

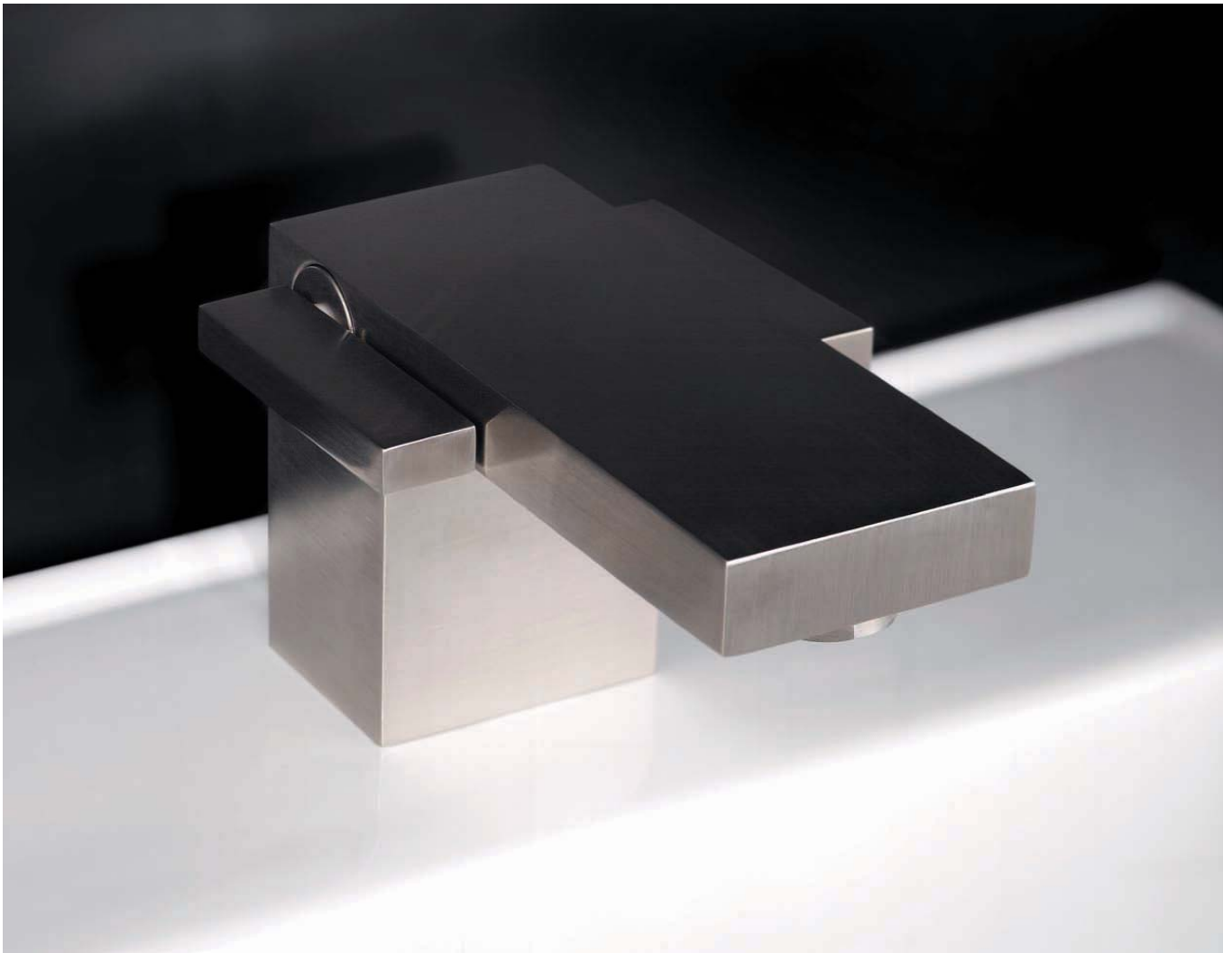

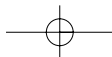

35505



Gruppo monoforo per lavabo, scarico aut. 1"1/4, flex di alimentazione.  
Single hole washbasin mixer with 1"1/4 aut. pop-up waste.

35555



Gruppo monoforo per bidet, scarico aut. 1" 1/4, flex di alimentazione.  
Single hole bidet mixer with 1" 1/4 pop-up waste, connection flex.

35025



Bocca bordo vasca a quattro fori con deviatore aut. completa di set doccia.  
Four-holes bathtub spout with aut. diverter complete of shower set.

35558



Batteria bidet a tre fori, scarico aut. 1"1/4.  
Three-holes bidet mixer with 1"1/4 pop-up waste.

35500



Batteria lavabo a tre fori con scarico aut. 1"1/4.  
Three holes washbasin mixer with 1"1/4 pop-up waste.

35501



Batteria lavabo a tre fori su piastra con scarico aut. 1"1/4.  
Three-holes washbasin mixer with plate and 1" 1/4 automatic pop-up waste.



35950



Miscelatore monocomando da incasso per doccia da 1/2".  
Single lever built-in shower mixer with 1/2" connection.

AC10445



Set saliscendi regolabile con attacco conico, doccia anticalcare e flessibile cromoflex.  
Set with adjustable sliding rail, conical bracket, lime resistant handshower, "cromoflex" flex. hose.

AC10066



Colonna doccia con soffione snodato per art. 35802.  
Rigid riser with jointed shower head, for art. 35802.

35970



Miscelatore monocomando vasca/doccia da incasso con deviatore aut.  
Single lever built-in bath/shower mixer with automatic diverter.

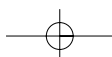

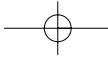

35630



Gruppo per vasca esterno con deviatore aut. supporto orientabile, doccia, flex. cm150.  
Bath set with automatic diverter adjustable bracket, handshower, flex. cm150.

35958



Miscelatore monocomando per lavabo da incasso senza scarico.  
Single lever built-in washbasin mixer without waste.

35536



Batteria lavabo a tre fori a parete con piastra corpo incasso art. AC00162.  
Three-holes wall-up washbasin mixer with plate without concealed part art. AC00162.

35830



Gruppo per doccia esterno con supporto orientabile, doccia e flex. 150 cm.  
Wall-up shower mixer with adjustable handshower bracket, handshower and flex. cm. 150.

35535



Batteria lavabo a tre fori a parete, senza corpo incasso art. AC00162.  
Three-holes wall-up washbasin mixer without concealed part art. AC00162.

35802



Gruppo per doccia esterno per art. AC10066 o art. AC10067.  
Wall-up shower mixer for art. AC10066 or for art. AC10067.

CARATTERISTICHE TECNICHE TECHNICAL FEATURES

AC10067



Colonna doccia con deviatore automatico, soffione snodato e doccia per art. 35802.  
Rigid riser with automatic diverter, jointed shower head and handshower, for art. 35802.

AC10069



Braccio doccia con attacco 1/2", soffione snodato 200x200 mm.  
Shower arm with 1/2" connection, 200x200 mm. jointed shower head.

AC04570



Bocca a parete, attacco 1/2".  
Wall spout, 1/2" connection.

AC10507



Sifone quadrato 1 1/4 per lavabo con due rubinetti filtro con arresto 1/2" x ø 10 mm.  
Square trap 1 1/4 for washbasin with two stop valves with filter, 1/2" x ø 10 mm.

AC10446



Presa acqua a parete 1/2" x 1/2".  
Water supply wall connection, 1/2" x 1/2".

AC10447



Rubinetto filtro con arresto 1/2" x ø 10 mm.  
Stop valve with filter, 1/2" x ø 10mm.

