

Soffione doccia a soffitto fisso in ottone, con n° 65 ugelli anticalcare, attacco ½", grande portata con risparmio d'acqua.

Fixed ceiling mounted shower head, brass, with 65 anti-lime nozzles, connection ½", big flow rate with water saving.

Pomme de douche fixe au plafond en laiton, 65 picots anticalcaires, raccord ½", grand débit avec épargne d'eau.

Fixe Deckenkopfbrause, Messing, mit 65 Anti-Kalk Düsen, Anschluss ½", große Durchlaufmenge mit Wassereinsparung.

Rociador fijo de techo en latón, 65 toberas anticalcáreas, racor ½", gran caudal con ahorro de agua.

FIGD10603 05 1.468,00

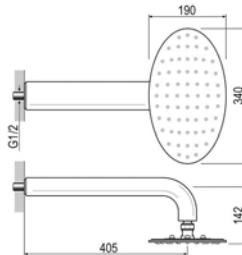

Soffione doccia a parete snodato in ottone, con n° 65 ugelli anticalcare, attacco ½", grande portata con risparmio d'acqua.

Joint ceiling mounted shower head, brass, with 65 anti-lime nozzles, connection ½", big flow rate with water saving.

Pomme de douche murale orientable en laiton, 65 picots anticalcaires, raccord ½", grand débit avec épargne d'eau.

Verstellbare Deckenkopfbrause, Messing, mit 65 Anti-Kalk Düsen, Anschluss ½", große Durchlaufmenge mit Wassereinsparung.

Rociador mural orientable en latón, 65 toberas anticalcáreas, racor ½", gran caudal con ahorro de agua.

FIGD10607 05 1.127,00

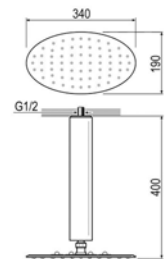

Soffione doccia a soffitto snodato in ottone, con n° 65 ugelli anticalcare, attacco ½", grande portata con risparmio d'acqua.

Joint ceiling mounted shower head, brass, with 65 anti-lime nozzles, connection ½", big flow rate with water saving.

Pomme de douche orientable au plafond en laiton, 65 picots anticalcaires, raccord ½", grand débit avec épargne d'eau.

Verstellbare Deckenkopfbrause, Messing, mit 65 Anti-Kalk Düsen, Anschluss ½", große Durchlaufmenge mit Wassereinsparung.

Rociador orientable de techo en latón, toberas anticalcáreas, racor ½", gran caudal con ahorro de agua.

FIGD10605 05 1.127,00

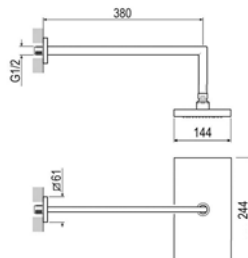

Soffione doccia 244x144 snodato in ABS, ugelli anticalcare, con braccio a parete, attacco ½".

Joint shower head 244x144, ABS, lime resistant nozzles, with wall-mounted shower arm, connection ½".

Pomme de douche 244x144 orientable en ABS, picots anticalcaires, bras mural, raccord ½".

Verstellbare Kopfbrause 244x144, ABS, Anti-Kalk Düsen, mit Wand-Brausearm, Anschluss ½".

Rociador 244x144 orientable en ABS, toberas anticalcáreas, brazo ducha mural, racor ½".

FIGD10069 05 578,00

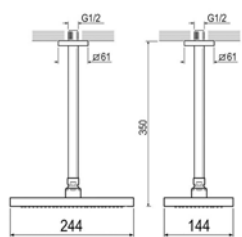

Soffione doccia 244x144 snodato in ABS, ugelli anticalcare, con braccio a soffitto, attacco ½".

Joint shower head 244x144, ABS, lime resistant nozzles, with ceiling-mounted shower arm, connection ½".

Pomme de douche 244x144 orientable en ABS, picots anticalcaires, bras au plafond, raccord ½".

Verstellbare Kopfbrause 244x144, ABS, Anti-Kalk Düsen, mit Decken-Brausearm, Anschluss ½".

Rociador 244x144 orientable en ABS, toberas anticalcáreas, brazo ducha al techo, racor ½".

FIGD10070 05 555,00

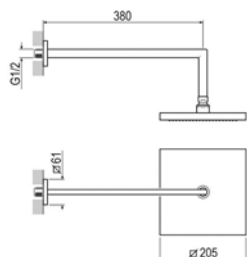

Soffione doccia 205x205 snodato in ABS, ugelli anticalcare, con braccio a parete, attacco ½".

Joint shower head 205x205, ABS, lime resistant nozzles, with wall-mounted shower arm, connection ½".

Pomme de douche 205x205 orientable en ABS, picots anticalcaires, bras mural, raccord ½".

Verstellbare Kopfbrause 205x205, ABS, Anti-Kalk Düsen, mit Wand-Brausearm, Anschluss ½".

Rociador 205x205 orientable en ABS, toberas anticalcáreas, brazo ducha a pared, racor ½".

FIGD10645 05 428,00

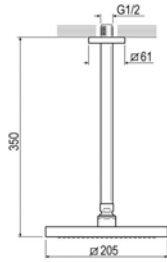

Soffione doccia 205x205 snodato in ABS, ugelli anticalcare, con braccio a soffitto, attacco 1/2".

FIGD10646 05 405,00

Joint shower head 205x205, ABS, lime resistant nozzles, with ceiling-mounted shower arm, connection 1/2".

Pomme de douche 205x205 orientable en ABS, picots anticalcaires, bras au plafond, raccord 1/2".

Verstellbare Kopfbrause 205x205, ABS, Anti-Kalk Düsen, mit Decken-Brausearm, Anschluss 1/2".

Rociador 205x205 orientable en ABS, toberas anticalcáreas, brazo ducha al techo, racor 1/2".

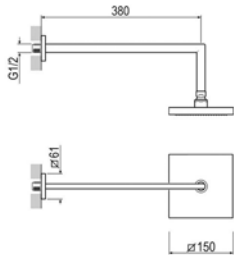

Soffione doccia 150x150 snodato in ABS, ugelli anticalcare, con braccio a parete, attacco 1/2".

FIGD10647 05 197,00

Joint shower head 150x150, ABS, lime resistant nozzles, with wall-mounted shower arm, connection 1/2".

Pomme de douche 150x150 orientable en ABS, picots anticalcaires, bras mural, raccord 1/2".

Verstellbare Kopfbrause 150x150, ABS, Anti-Kalk Düsen, mit Wand-Brausearm, Anschluss 1/2".

Rociador 150x150 orientable en ABS, toberas anticalcáreas, brazo ducha a pared, racor 1/2".

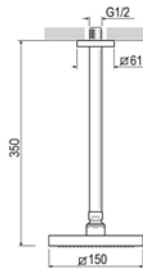

Soffione doccia 150x150 snodato in ABS, ugelli anticalcare, con braccio a soffitto, attacco 1/2".

FIGD10648 05 186,00

Joint shower head 150x150, ABS, lime resistant nozzles, with ceiling-mounted shower arm, connection 1/2".

Pomme de douche 150x150 orientable en ABS, picots anticalcaires, bras au plafond, raccord 1/2".

Verstellbare Kopfbrause 150x150, ABS, Anti-Kalk Düsen, mit Decken-Brausearm, Anschluss 1/2".

Rociador 150x150 orientable en ABS, toberas anticalcáreas, brazo ducha al techo, racor 1/2".

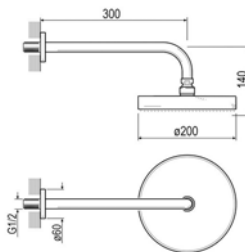

Soffione doccia d.200 snodato in ABS, ugelli anticalcare, con braccio a parete, attacco 1/2".

FIGD10099 05 210,00

Joint shower head Ø 200, ABS, lime resistant nozzles, with wall-mounted shower arm, connection 1/2".

Pomme de douche Ø 200 orientable en ABS, picots anticalcaires, bras mural, raccord 1/2".

Verstellbare Kopfbrause Ø 200, ABS, Anti-Kalk Düsen, mit Wand-Brausearm, Anschluss 1/2".

Rociador Ø 200 orientable en ABS, toberas anticalcáreas, brazo ducha a pared, racor 1/2".

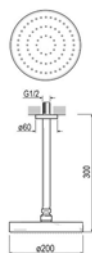

Soffione doccia d.200 snodato in ABS, ugelli anticalcare, con braccio a soffitto, attacco 1/2".

FIGD10628 05 187,00

Joint shower head Ø 200, ABS, lime resistant nozzles, with ceiling-mounted shower arm, connection 1/2".

Pomme de douche Ø 200 orientable en ABS, picots anticalcaires, bras au plafond, raccord 1/2".

Verstellbare Kopfbrause Ø 200, ABS, Anti-Kalk Düsen, mit Decken-Brausearm, Anschluss 1/2".

Rociador Ø 200 orientable en ABS, toberas anticalcáreas, brazo ducha al techo, racor 1/2".

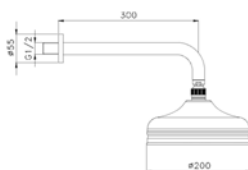

Soffione doccia d.200 snodato in ottone, ugelli anticalcare, con braccio a parete, attacco 1/2".

FIGD10065 05 379,00

Joint shower head Ø 200, ABS, lime resistant nozzles, with wall-mounted shower arm, connection 1/2".

Pomme de douche Ø 200 orientable en laiton, picots anticalcaires, bras mural, raccord 1/2".

Verstellbare Kopfbrause Ø 200, ABS, Anti-Kalk Düsen, mit Wand-Brausearm, Anschluss 1/2".

Rociador Ø 200 orientable en latón, toberas anticalcáreas, brazo ducha a pared, racor 1/2".

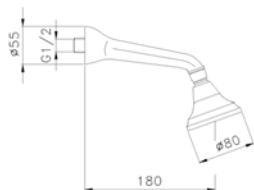

Soffione doccia snodato monogetto, con braccio a parete, attacco 1/2".

FIGD10040 05 92,00

Joint single-jet shower head, ABS, with wall-mounted shower arm, connection 1/2".

Pomme de douche orientable monojet, bras mural, raccord 1/2".

Verstellbare 1-Strahl Kopfbrause, mit Wand-Brausearm, Anschluss 1/2".

Rociador orientable monochorro, brazo ducha a pared, racor 1/2".

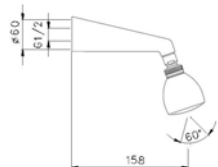

Soffione doccia snodato ugelli anticalcare monogetto, con braccio a parete, attacco 1/2".

FIGD10638 05 77,00

Joint single-jet shower head, lime resistant nozzles, with wall-mounted shower arm, connection 1/2".

Pomme de douche orientable monojet, picots anticalcaires, bras mural, raccord 1/2".

Verstellbare 1-Strahl Kopfbrause, Anti-Kalk Düsen, mit Wand-Brausearm, Anschluss 1/2".

Rociador orientable monochorro, toberas anticalcáreas, brazo ducha a pared, racor 1/2".

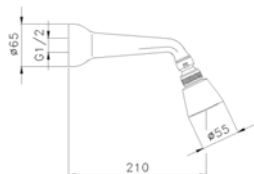

Soffione doccia snodato monogetto, con braccio a parete, attacco 1/2".

FIGD10003 05 37,00

Joint single-jet shower head, with wall-mounted shower arm, connection 1/2".

Pomme de douche orientable monojet, bras mural, raccord 1/2".

Verstellbare 1-Strahl Kopfbrause, mit Wand-Brausearm, Anschluss 1/2".

Rociador orientable monochorro, brazo ducha a pared, racor 1/2".

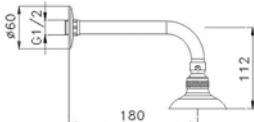

Soffione doccia snodato monogetto, con braccio a parete, attacco 1/2".

FIGD10626 05 29,00

Joint single-jet shower head, with wall-mounted shower arm, connection 1/2".

Pomme de douche orientable monojet, bras mural, raccord 1/2".

Verstellbare 1-Strahl Kopfbrause, mit Wand-Brausearm, Anschluss 1/2".

Rociador orientable monochorro, brazo ducha a pared, racor 1/2".



Doccetta a parete incasso, snodata con ugelli anticalcare, attacco 1/2".

FIGD10677 05 125,00

Joint body jet, lime resistant nozzles, connection 1/2".

Douchette latérale orientable à encastrer, picots anticalcaires, raccord 1/2".

Verstellbare Seitenbrause, Anti-Kalk Düsen, Anschluss 1/2".

Jet lateral orientable empotrado, toberas anticalcáreas, racor 1/2".



Doccetta a parete incasso, snodata con ugelli anticalcare, attacco 1/2".

FIGD10678 05 116,00

Joint body jet, lime resistant nozzles, connection 1/2".

Douchette latérale orientable à encastrer, picots anticalcaires, raccord 1/2".

Verstellbare Seitenbrause, Anti-Kalk Düsen, Anschluss 1/2".

Jet lateral orientable empotrado, toberas anticalcáreas, racor 1/2".

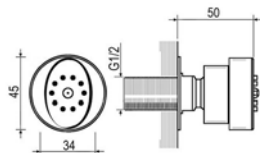

Doccetta a parete laterale snodata con ugelli anticalcare, attacco 1/2".

FIGD10617 05 88,00

Joint body jet, lime resistant nozzles, connection 1/2".

Douchette latérale orientable, picots anticalcaires, raccord 1/2".

Verstellbare Seitenbrause, Anti-Kalk Düsen, Anschluss 1/2".

Jet lateral orientable, toberas anticalcáreas, racor 1/2".

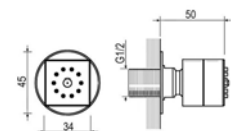

Doccetta a parete laterale snodata con ugelli anticalcare, attacco 1/2".

FIGD10622 05 69,00

Joint body jet, lime resistant nozzles, connection 1/2".

Douchette latérale orientable, picots anticalcaires, raccord 1/2".

Verstellbare Seitenbrause, Anti-Kalk Düsen, Anschluss 1/2".

Jet lateral orientable, toberas anticalcáreas, racor 1/2".

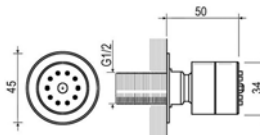

Doccetta a parete laterale snodata con ugelli anticalcare, attacco 1/2".

FIGD10621 05 61,00

Joint body jet, lime resistant nozzles, connection 1/2".

Douchette latérale orientable, picots anticalcaires, raccord 1/2".

Verstellbare Seitenbrause, Anti-Kalk Düsen, Anschluss 1/2".

Jet lateral orientable, toberas anticalcáreas, racor 1/2".

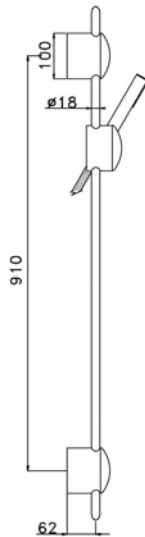

Set saliscendi regolabile con attacco conico, doccia anticalcare e flessibile Cromoflex.

FICS10609 05 560,00

Set with adjustable sliding rail, conical bracket, lime resistant handshower, Cromoflex hose flexible hose.hose.

Barre murale réglable avec support conique, douchette anticalcaire et flexible Cromoflex.

Brausestange mit konisch.Brausehalter, Brause mit Antikalk-Funktion, flex. Schlauch Cromoflex.

Barra de ducha regulable con soporte conico, ducha anticalcare y flexo Cromoflex.

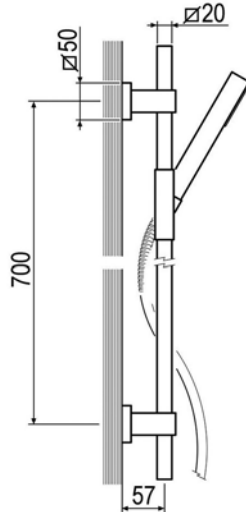

Set saliscendi regolabile con attacco conico, doccia anticalcare plurijetto e flessibile Cromoflex 150 cm.

FICS10445 05 520,00

Set with adjustable sliding rail, conical bracket, lime resistant single jet handshower and Cromoflex flexible hose 150 cm.

Barre murale réglable avec support conique, douchette anticalcaire monojet et flexible Cromoflex cm 150.

Set mit verstellbarer Brausestange und verstellbarem Brausehalter, Anti-Kalk 1-Strahl Handbrause und Flexschlauch Cromoflex 150 cm.

Barra de ducha regulable, soporte cónico, ducha anticalcárea monochorro, flex. Cromoflex cm 150.

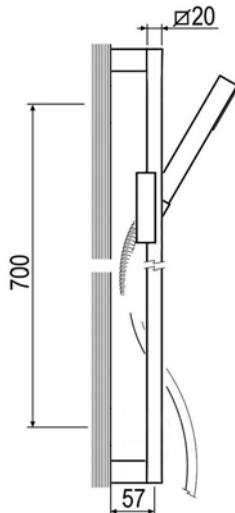

Set saliscendi regolabile con attacco conico completo di doccia anticalcare monogetto e flessibile doppia aggraffatura 150 cm.

FICS10463 05 223,00

Complete set of sliding rail 55 cm, single-jet handshower, adjustable bracket, 150 cm double clamp flexible shower hose.

Set barre de douche réglable cm 55, complet de douchette monojet, support réglable, flex. double agrafage cm 150.

Set mit verstellbarer Brausestange 55 cm, komplett mit 1-Strahl Handbrause, verstellbarer Brausehalter, Flexschlauch Doppelverklebung 150 cm.

Juego barra de ducha regulable cm 55, con ducha monochorro, soporte orientable, flex. doble engatillado cm 150.

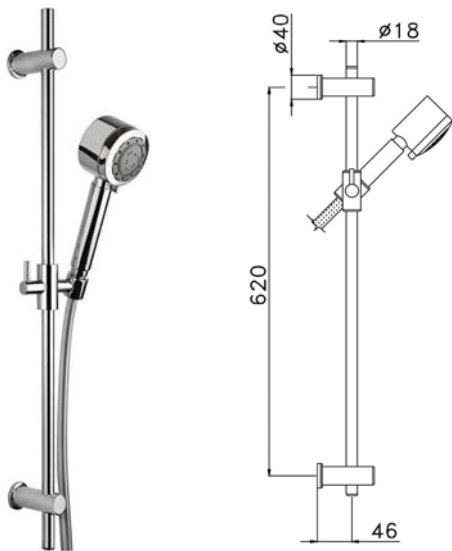

Set saliscendi regolabile con attacco conico, doccia 4 getti e flessibile Cromoflex cm. 150.

FICS10438 05 284,00

Set with adjustable sliding rail, conical bracket, 4-jet handshower and Cromoflex flexible hose 150 cm.

Barre murale réglable avec support conique, douchette 4 jets et flexible Cromoflex cm. 150.

Verstellbares Brausestangen-Set mit konischem Brausehalter, 4-Strahl-Brause, flex. Schlauch Cromoflex 150 cm.

Barra de ducha regulable con soporte conico, ducha 4 funciones y flexo Cromoflex cm. 150.

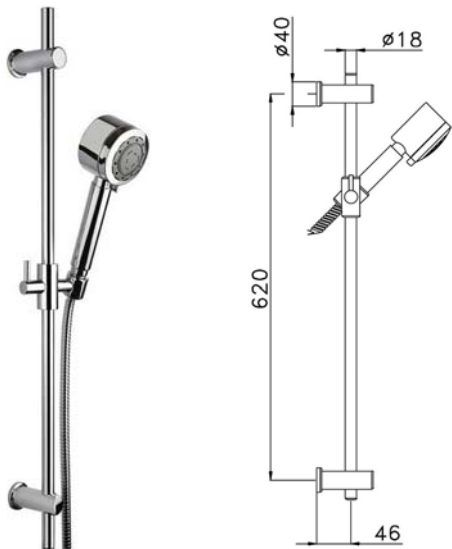

Set saliscendi regolabile con attacco conico completo di doccia 4 getti e flessibile ottone doppia aggraffatura cm 150.

FICS10442 05 261,00

Set with adjustable sliding rail, conical bracket, 4-jet handshower and flexible hose double clamping 150 cm.

Barre murale réglable avec support conique complet de douchette 4 jets et flexible double agrafage cm 150.

Verstellbares Brausestangen-Set mit konischem Brausehalter, 4-Strahl-Brause, flex. Schlauch 150 cm, schwere Ausführung.

Barra de ducha regulable con soporte conico, ducha 4 funciones y flexo doble engatillado cm 150.

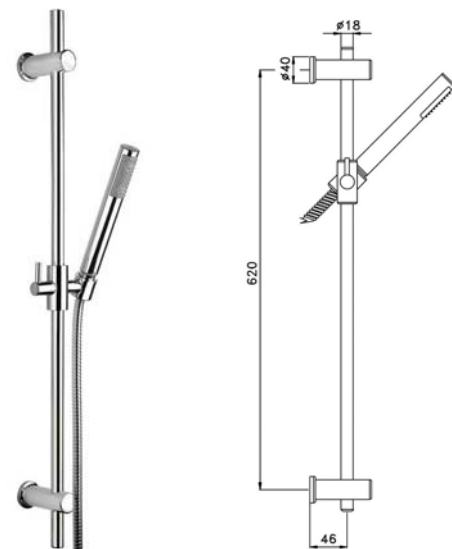

Set saliscendi regolabile con attacco conico completo di doccia anticalcare multigetto e flessibile ottone doppia aggraffatura cm. 150.

FICS10434 05 247,00

Set with adjustable sliding rail, conical bracket, complete with lime resistant handshower and flexible hose double clamping 150 cm.

Barre murale réglable avec support conique complet de douchette anticalcaire et flexible double agrafage cm. 150.

Verstellbares Brausestangen-Set mit konischem Brausehalter, Anti-Kalk-Brause, flex. Schlauch 150 cm, schwere Ausführung.

Barra de ducha regulable con soporte conico, ducha anticalcare y flexo doble engatillado cm 150.

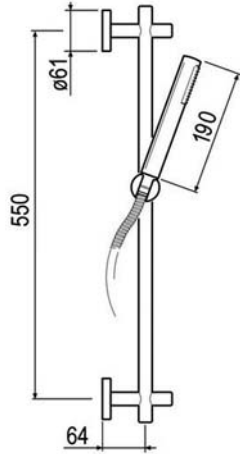

Set saliscendi regolabile con attacco conico completo di doccia anticalcare monogetto e flessibile doppia aggraffatura cm 150.

Set with adjustable sliding rail, conical bracket, complete with lime resistant single-jet handshower and flexible hose double clamping 150 cm.

Barre murale réglable avec support conique complet de douche anticalcaire monojet et flexible double agrafage cm 150.

Set mit verstellbarer Brausestange und verstellbarem Brausehalter, komplett mit Anti-Kalk 1-Strahl Handbrause und Flexschlauch Doppelverklemmung 150 cm.

Barra de ducha regulable con soporte cónico, ducha anticalcárea y flex. doble engatillado cm 150.

FICS10451 05 135,00

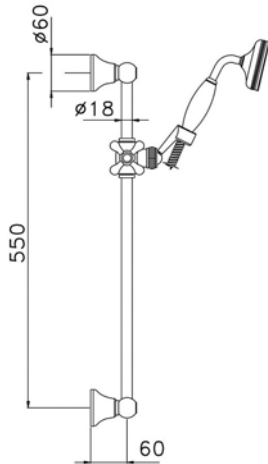

Set saliscendi regolabile in ottone con attacco conico, doccia plurigetto, flessibile ottone doppia aggraffatura cm. 150.

Set with adjustable brass sliding rail, conical bracket, handshower and flexible hose double clamping 150 cm.

Barre murale réglable en laiton avec support conique, douche et flexible double agrafage cm 150.

Brausestange aus Messing mit konischem Brausehalter, Brause, flex. Schlauch 150 cm, schwere Ausführung.

Barra de ducha regulable en latón con soporte conico, ducha y flexo doble engatillado cm 150.

FICS10440 05 271,00

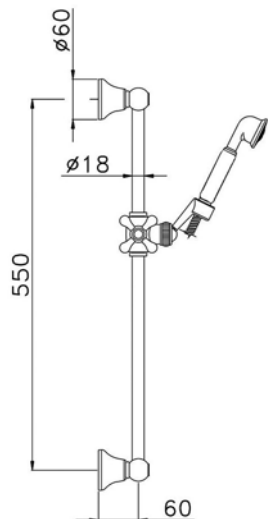

Set saliscendi regolabile in ottone con attacco conico, doccia Princesse, flessibile doppia aggraffatura.

Set with adjustable brass sliding rail, conical bracket, Princesse handshower, flexible hose.

Barre murale réglable en laiton avec support conique, douche Princesse et flexible.

Brausestange aus Messing mit konischem Brausehalter, Princesse Brause, flex.Schlauch.

Barra de ducha regulable en latón con soporte conico, ducha Princesse y flexo doble engatillado.

FICS10412 05 220,00

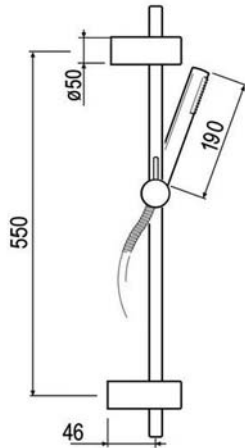

Set saliscendi regolabile con attacco conico completo di doccia anticalcare plurigetto, flessibile ottone doppia aggraffatura 150 cm.

Set with adjustable sliding rail, conical bracket, complete with lime resistant single-jet handshower and flexible hose double clamping 150 cm.

Barre murale réglable avec raccord conique, complète de douche anticalcaire monojet et flexible double agrafage 150 cm.

Set mit verstellbarer Brausestange und verstellbarem Brausehalter, komplett mit Anti-Kalk 1-Strahl Handbrause und Flexschlauch Doppelverklebung 150 cm.

Set barra de ducha regulable, soporte cónico, ducha anticalcárea monochorro, flex. doble engatillado cm 150.

FICS10233 05 117,00

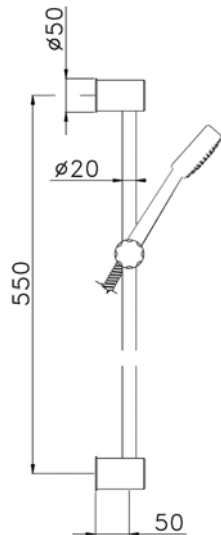

Set saliscendi regolabile con attacco conico completo di doccia anticalcare monogetto e flessibile doppia aggraffatura 150 cm.

Set with adjustable sliding rail, conical bracket, complete with lime resistant single-jet handshower and flexible hose double clamping 150 cm.

Barre murale réglable avec raccord conique, complète de douche anticalcaire monojet et flexible double agrafage 150 cm.

Set mit verstellbarer Brausestange und verstellbarem Brausehalter, komplett mit Anti-Kalk 1-Strahl Handbrause und Flexschlauch Doppelverklebung 150 cm.

Set barra de ducha regulable, soporte cónico, ducha anticalcárea monochorro, flex. doble engatillado cm 150.

FICS10464 05 86,00

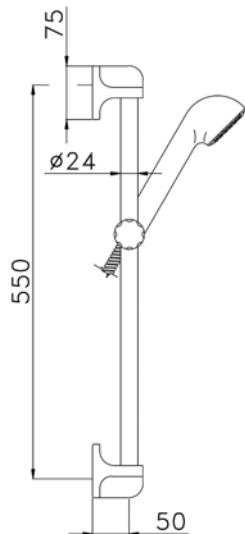

Set saliscendi regolabile 55 cm, completo di doccia anticalcare plurigetto, supporto orientabile, flessibile ottone doppia aggraffatura 150 cm.

Complete set of sliding rail 55 cm, lime resistant single-jet handshower, adjustable bracket, 150 cm double clamp flexible shower hose.

Set barre de douche réglable cm 55, complet de douchette anticalcaire monojet, support réglable, flex. double agrafage cm 150.

Set mit verstellbarer Brausestange 55 cm, komplett mit Anti-Kalk 1-Strahl Handbrause, verstellbarer Brausehalter, Flexschlauch Doppelverklebung 150 cm.

Juego barra de ducha regulable cm 55, ducha anticalcárea monochorro, soporte orientable, flex. doble engatillado cm 150.

FICS10411 05 103,00

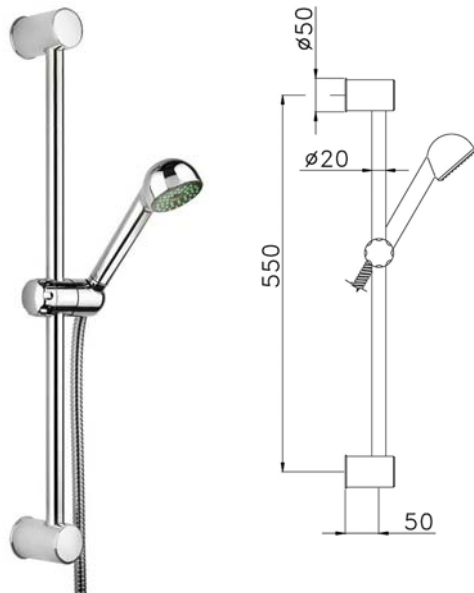

Set saliscendi regolabile 55 cm, completo di doccia anticalcare plurigetto, supporto orientabile, flessibile ottone doppia aggraffatura 150 cm.

FICS10413 05 68,00

Complete set of sliding rail 55 cm, lime resistant single-jet handshower, adjustable bracket, 150 cm double clamp flexible shower hose.

Set barre de douche réglable cm 55, complet de douchette anticalcaire monojet, support réglable, flex. double agrafage cm 150.

Set mit verstellbarer Brausestange 55 cm, komplett mit Anti-Kalk 1-Strahl Handbrause, verstellbarer Brausehalter, Flexschlauch Doppelverklemmung 150 cm.

Juego barra de ducha regulable cm 55, ducha anticalcárea monochorro, soporte orientable, flex. doble engatillado cm 150.

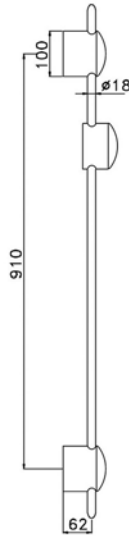

Saliscendi regolabile con attacco conico.

FICS10228 05 330,00

Adjustable sliding rail with conical bracket.

Barre murale réglable avec support conique.

Brausestange mit konischem Brausehalter.

Barra de ducha regulable con soporte conico.

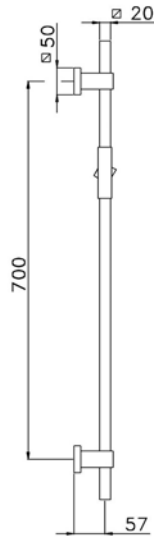

Saliscendi regolabile con attacco conico.

FICS10219 05 356,00

Adjustable sliding rail with conical bracket.

Barre murale réglable avec support conique.

Brausestange mit konischem Brausehalter.

Barra de ducha regulable con soporte conico.

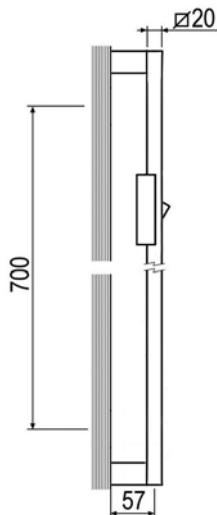

Saliscendi regolabile con attacco conico.

FICS10236 05 166,00

Adjustable sliding rail with conical bracket.

Barre murale réglable avec support conique.

Brausestange mit konischem Brausehalter.

Barra de ducha regulable con soporte conico.

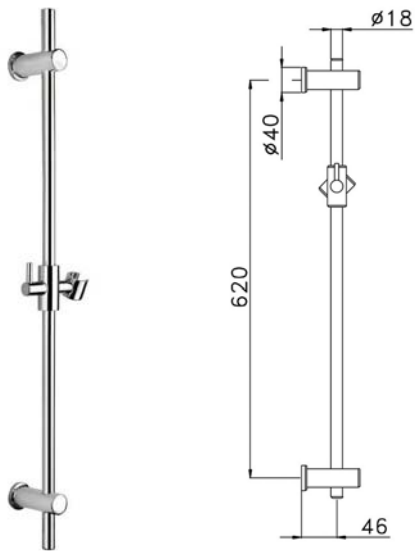

Saliscendi regolabile con attacco conico.

FICS10214 05 158,00

Adjustable sliding rail with conical bracket.

Barre murale réglable avec support conique.

Brausestange mit konischem Brausehalter.

Barra de ducha regulable con soporte conico.

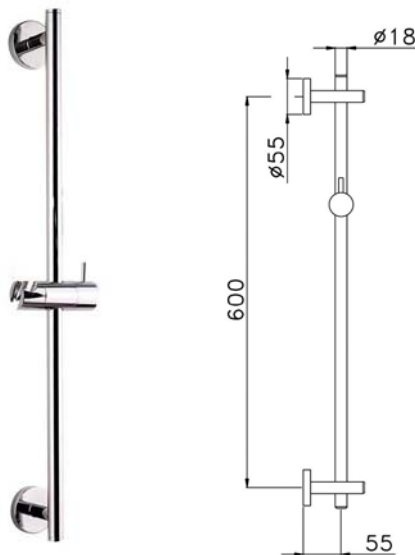

Saliscendi regolabile con attacco conico.

FICS10217 05 81,00

Adjustable sliding rail with conical bracket.

Barre murale réglable avec support conique.

Brausestange mit konischem Brausehalter.

Barra de ducha regulable con soporte conico.

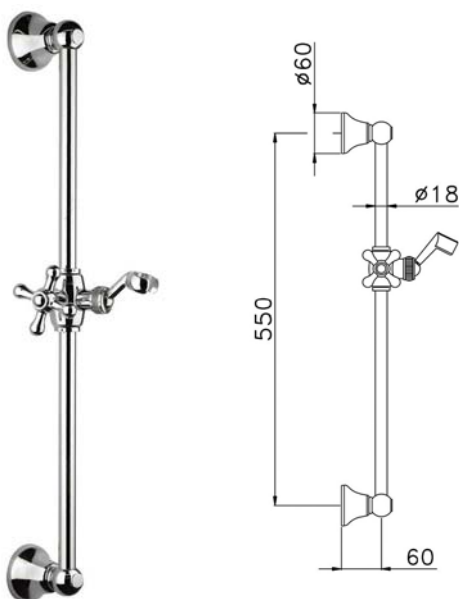

Saliscendi regolabile in ottone con attacco conico.

FICS10212 05 162,00

adjustable brass sliding rail with conical bracket.

Barre murale réglable en laiton avec support conique.

Brausestange aus Messing mit konischem Brausehalter.

Barra de ducha regulable en latón con soporte conico.

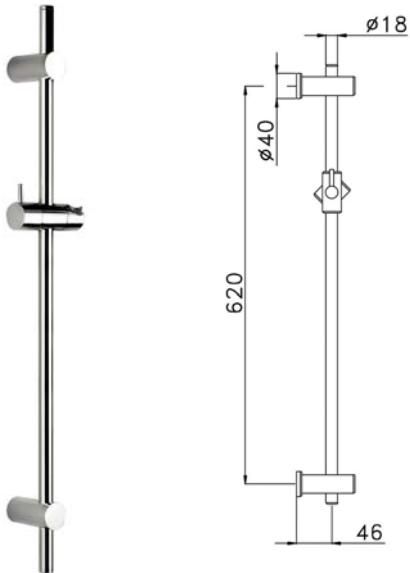

Saliscendi regolabile con attacco conico.

FICS10232 05 69,00

Adjustable sliding rail with conical bracket.

Barre murale réglable avec support conique.

Brauestange mit konischem Brausehalter.

Barra de ducha regulable con soporte conico.

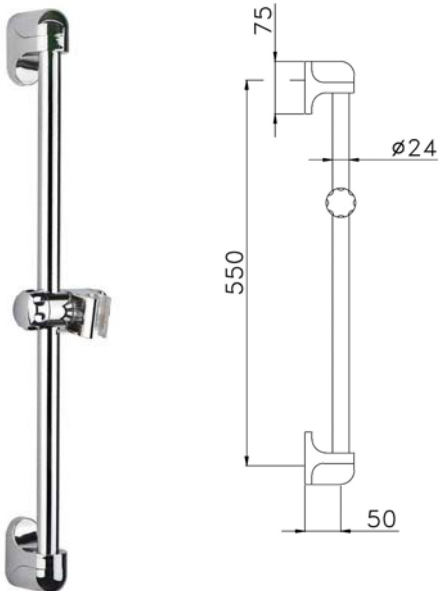

Saliscendi regolabile 55 cm, supporto orientabile.

FICS10207 05 76,00

Complete set of sliding rail 55 cm, adjustable bracket.

Barre de douche réglable cm 55, support orientable.

Verstellbare Brauestange 55 cm, verstellbarer Brausehalter.

Barra de ducha regulable cm 55, soporte orientable.

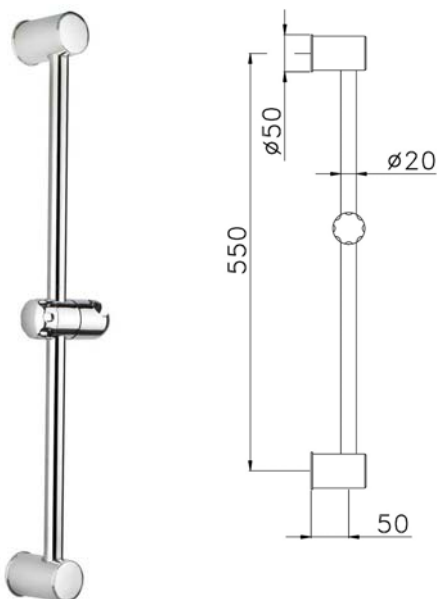

Saliscendi regolabile 55 cm, supporto orientabile.

FICS10208 05 51,00

Complete set of sliding rail 55 cm, adjustable bracket.

Barre de douche réglable cm 55, support orientable.

Verstellbare Brauestange 55 cm, verstellbarer Brausehalter.

Barra de ducha regulable cm 55, soporte orientable.

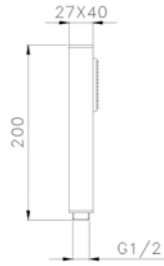

Doccia ovale anticalcare plurigetto.

FIGD10611 05 91,00

Hand shower oval, lime resistant, multiple-jet function.

Douchette ovale anticalcaire avec plusieurs jets.

Brause mit Antikalk-Funktion.

Ducha ovada anticalcárea plurichorros.

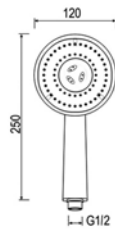

Doccia anticalcare 3 getti.

FIGD10618 05 113,00

Lime resistant handshower.

Douchette anticalcaire.

Anti-Kalk-Brause.

Ducha anticalcarea.

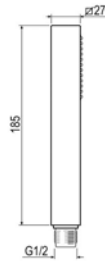

Doccia anticalcare plurigetto.

FIGD10068 05 66,00

Hand shower lime resistant, multiple-jet function.

Douchette anticalcaire avec plusieurs jets.

Brause Anti-Kalk, Mehr-Strahl Funktion.

Ducha anticalcárea plurichorros.

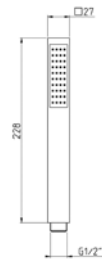

Doccia anticalcare plurigetto.

FIGD10097 05 42,00

Hand shower lime resistant, multiple-jet function.

Douchette anticalcaire avec plusieurs jets.

Brause Anti-Kalk, Mehr-Strahl Funktion.

Ducha anticalcárea plurichorros.

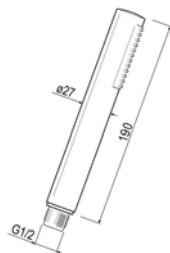

Doccia anticalcare plurigetto.

FIGD10034 05 49,00

Hand shower lime resistant, multiple-jet function.

Douchette anticalcaire avec plusieurs jets.

Brause Anti-Kalk, Mehr-Strahl Funktion.

Ducha anticalcárea plurichorros.

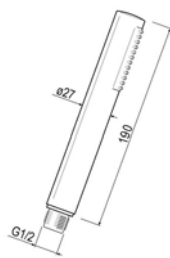

Doccia anticalcare plurigetto.

FIGD10631 05 31,00

Hand shower lime resistant, multiple-jet function.

Douchette anticalcaire avec plusieurs jets.

Brause Anti-Kalk, Mehr-Strahl Funktion.

Ducha anticalcárea plurichorros.

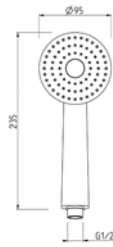

Doccia anticalcare plurigetto.

Hand shower lime resistant, multiple-jet function.

Douchette anticalcaire avec plusieurs jets.

Brause Anti-Kalk, Mehr-Strahl Funktion.

Ducha anticalcárea plurichorros.

FIGD10640 05 38,00

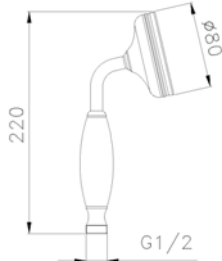

Doccia antica plurigetto.

Hand shower "rétro", multiple-jet function.

Douchette rétro avec plusieurs jets.

Brause "rétro", Mehr-Strahl Funktion.

Ducha "rétro" plurichorros.

FIGD10059 05 74,00

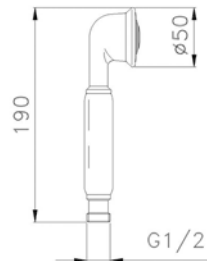

Doccia antica plurigetto.

Hand shower "rétro", multiple-jet function.

Douchette rétro avec plusieurs jets.

Brause "rétro", Mehr-Strahl Funktion.

Ducha "rétro" plurichorros.

FIGD10018 05 42,00

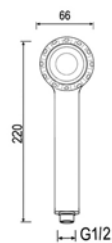

Doccia anticalcare 2 getti.

Lime resistant double-jets handshower.

Douchette anticalcaire 2 jets.

Anti-Kalk 2-Strahl Handbrause.

Ducha anticalcárea 2 chorros.

FIGD10629 05 37,00

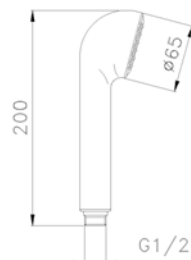

Doccia anticalcare plurigetto.

Hand shower lime resistant, multiple-jet function.

Douchette anticalcaire avec plusieurs jets.

Brause Anti-Kalk, Mehr-Strahl Funktion.

Ducha anticalcárea plurichorros.

FIGD10008 05 32,00

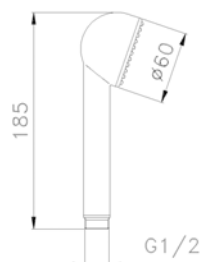

Doccia anticalcare plurigetto.

Hand shower lime resistant, multiple-jet function.

Douchette anticalcaire avec plusieurs jets.

Brause Anti-Kalk, Mehr-Strahl Funktion.

Ducha anticalcárea plurichorros.

FIGD10006 05 15,00

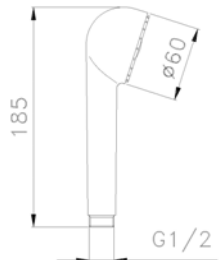

Doccia plurigetto.

Hand shower, multiple-jet function.

Douchette avec plusieurs jets.

Brause, Mehr-Strahl Funktion.

Ducha plurichorros.

FIGD10001 05 12,00

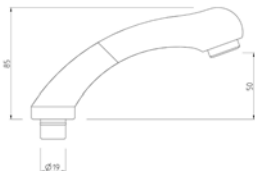

Doccia per lavabo parrucchiere.

Shower for hairdresser washbasin.

Douchette coiffeur.

Brause für Frisör-Waschtisch.

Ducha para lavabo para peluquero.

FIGD10012 05 27,00

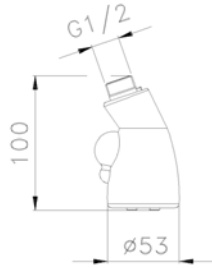

Doccia anticalcare 2 getti con rompigitto per miscelatore lavello.

FIGD10039 05 92,00

Double jet lime resistant handshower with spout breaker for sink mixer.

Douchette anticalcaire 2 jets avec brise-jet pour mitigeur évier.

2-Strahl Geschirrbrause mit Antikalk-Funktion mit Strahlregler für Spülen-Einhebelmischer.

Ducha anticalcare de chorro doble con rompichorro para mezclador fregadero.

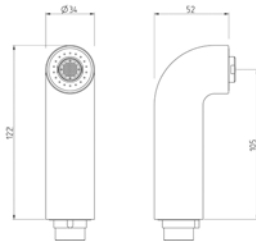

Doccia 2 getti , con valvola di ritegno ,per miscelatore lavello.

FIGD10658 05 44,00

Double-jets handshower for sink mixer.

Douchette 2 jets pour mitigeur évier.

2-Strahl Brause für Spülen-Einhebelmischer.

Ducha de chorro doble para mezclador fregadero.

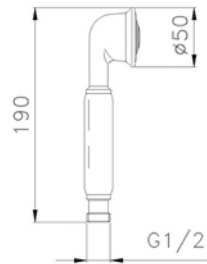

Doccia anticalcare 2 getti per miscelatore lavello.

FIGD10641 05 46,00

Double-jets handshower for sink mixer.

Douchette 2 jets pour mitigeur évier.

2-Strahl Brause für Spülen-Einhebelmischer.

Ducha de chorro doble para mezclador fregadero.

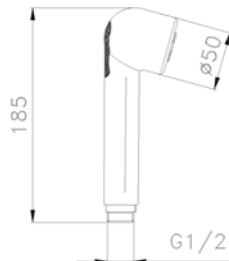

Doccia 2 getti per miscelatore lavello.

FIGD10004 05 39,00

Double-jets handshower for sink mixer.

Douchette 2 jets pour mitigeur évier.

2-Strahl Brause für Spülen-Einhebelmischer.

Ducha 2 chorros para mezclador para fregadero.

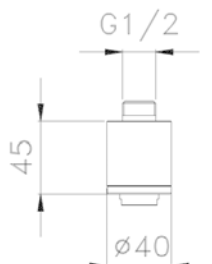

Doccia monogetto con rompigitto per miscelatore lavello.

FIGD10045 05 41,00

Single jet handshower with spout breaker for sink mixer.

Douchette monojet avec brise-jet pour mitigeur évier.

1-Strahl Geschirrbrause mit Strahlregler für Spülen-Einhebelmischer.

Ducha de chorro único con rompichorro para mezclador fregadero.



Doccia monogetto con rompigitto per miscelatore lavello.

FIGD10659 05 29,00

Single jet handshower with spout breaker for sink mixer.

Douchette monojet avec brise-jet pour mitigeur évier.

1-Strahl Geschirrbrause mit Strahlregler für Spülen-Einhebelmischer.

Ducha de chorro único con rompichorro para mezclador fregadero.

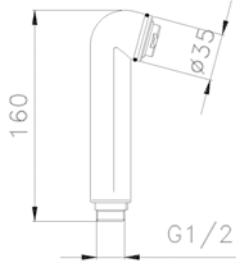

Doccia monogetto per miscelatore lavello.

Single-jet handshower for sink mixer.

Douchette monojet pour mitigeur évier.

1-Strahl Brause für Spülen-Einhebelmischer.

Ducha monochorro para mezclador para fregadero.

FIGD10016 05 22,00

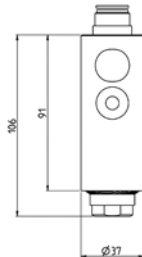

Doccia cilindrica monogetto.

Single-jet hand shower, cylindrical.

Douchette anticalcaire monojet.

1-Strahl Handbrause, zylinderförmig.

Ducha cilíndrica monochorro.

FIGD10676 05 128,00

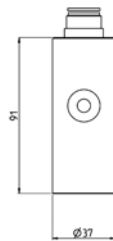

Doccia cilindrica 2 getti.

Double-jet hand shower, cylindrical.

Douchette cylindrique 2 jets.

2-Strahl Handbrause, zylinderförmig.

Ducha cilíndrica 2 funciones.

FIGD10601 05 108,00



Doccia cilindrica monogetto, funzione Cromoterapia.

Single-jet hand shower, cylindrical, with Chromotherapy function.

Douchette cylindrique monojet, fonction Chromothérapie.

1-Strahl Handbrause, zylinderförmig, mit Funktion Chromotherapy.

Ducha cilíndrica onochorro, función Cromoterapia.

FIGD10690 05 285,00

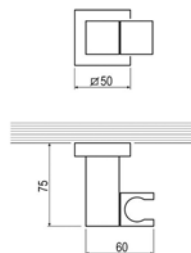
LED light

Supporto doccia regolabile.

Adjustable handshower bracket.

Support douche réglable.

Verstellbarer Brausehalter.

Soporte ducha regulable.

FIGD10220 05 99,00

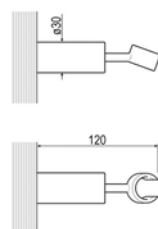

Supporto doccia regolabile.

Adjustable handshower bracket.

Support douche réglable.

Verstellbarer Brausehalter.

Soporte ducha regulable.

FIGD10226 05 45,00

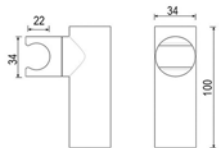

Supporto doccia regolabile.

FIGD10330 05 15,00

Adjustable handshower bracket.

Support douche orientable.

Verstellbarer Brausehalter.

Soporte ducha regulable.

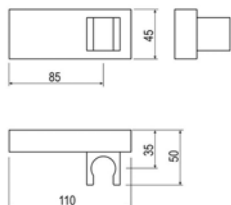

Supporto doccia fisso

FIGD10234 05 23,00

Fixed handshower bracket.

Support douche fixe.

Fixer Brausehalter.

Soporte fijo para ducha.

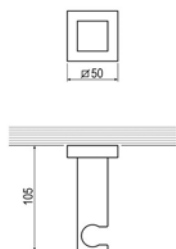

Supporto doccia fisso.

FIGD10222 05 79,00

Fixed hand shower bracket.

Support fixe pour douche.

Fixer Brausehalter.

Soporte fijo para ducha.

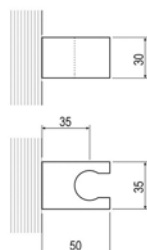

Supporto doccia fisso in ABS.

FIGD10235 05 10,00

Fixed hand shower bracket, ABS.

Support fixe pour douche en ABS.

Fixer Brausehalter in ABS.

Soporte fijo para ducha en ABS.

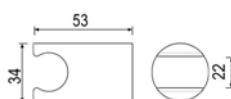

Supporto doccia fisso.

FIGD10331 05 7,00

Fixed handshower bracket.

Support douche fix.

Fixer Brausehalter.

Soporte ducha fijo.

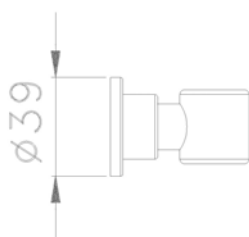

Supporto doccia fisso in ottone.

FIGD10229 05 45,00

Fixed hand shower bracket, brass.

Support fixe pour douche en laiton.

Fixer Brausehalter in Messing.

Soporte fijo para ducha en latón.

	 <p>55 ø45</p>	<p>Supporto doccia fisso.</p> <p>Fixed bracket.</p> <p>Support douche fixe.</p> <p>Fixer Brausehalter.</p> <p>Soporte ducha fijo.</p>	<p><u>FIGD10204 05 10,00</u></p>
	 <p>55 110 38 80</p>	<p>Supporto doccia regolabile.</p> <p>Adjustable bracket.</p> <p>Support douche réglable.</p> <p>Verstellbarer Brausehalter.</p> <p>Soporte ducha regulable.</p>	<p><u>FIGD10203 05 15,00</u></p>
	 <p>105 ø60</p>	<p>Supporto doccia regolabile in ottone.</p> <p>Brass adjustable handshower bracket.</p> <p>Support douche réglable en laiton.</p> <p>Verstellbarer Brausehalter aus Messing.</p> <p>Soporte ducha regulable en latón.</p>	<p><u>FIGD10206 05 23,00</u></p>
	 <p>105 ø60</p>	<p>Supporto doccia regolabile.</p> <p>Adjustable bracket.</p> <p>Support douche réglable.</p> <p>Verstellbarer Brausehalter.</p> <p>Soporte ducha regulable.</p>	<p><u>FIGD10209 05 11,00</u></p>
	 <p>ø50 G1/2 G1/2 105 45</p>	<p>Supporto doccia fisso con presa acqua 1/2"x1/2".</p> <p>Fixed handshower bracket with water supply, 1/2"x1/2".</p> <p>Support douche fix avec prise d'eau 1/2"x1/2".</p> <p>Fixer Brausehalter mit Wasseranschluss 1/2"x1/2".</p> <p>Soporte ducha fijo con toma de agua, 1/2"x1/2".</p>	<p><u>FIGD10620 05 79,00</u></p>
	 <p>G1/2 65 32 G1/2 25 ø35</p>	<p>Supporto doccia fisso con presa acqua 1/2"x1/2".</p> <p>Handshower bracket with water supply.</p> <p>Support douche avec prise d'eau.</p> <p>Brausehalter mit Wasseranschluss.</p> <p>Soporte ducha con toma de agua.</p>	<p><u>FIGD10619 05 73,00</u></p>

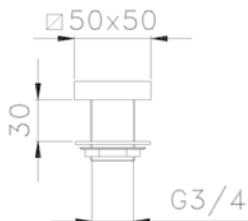

Base portadoccia 3/4" con attacco conico.

FIGD10218 05 34,00

Conical shower holder, 1/2".

Porte-douchette conique 1/2".

Konische Brausedurchführung 1/2".

Base portaducha 1/2" con soporte conico.



Base portadoccia 3/4", per doccia laterale estraibile.

FIGD10211 05 25,00

Conical shower holder, 3/4" connection, for hairdresser washbasin.

Porte-douchette conique 3/4".

Konische Brausedurchführung 3/4", für Frisör-Waschtisch.

Base portaducha 3/4" con soporte conico.



Base portadoccia 3/4", per lavabo parucchiere.

FIGD10210 05 25,00

Handshower holder, for hairdresser washbasin.

Base porte-douchette pour lavabo coiffeur.

Brausehalter, für Frisör-Waschtisch.

Base porta-ducha para lavabo para peluquero.

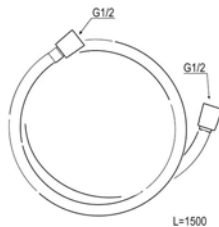

Flessibile Cromoflex 1/2"x1/2", 150 cm, calotta conica antitorsione.

FIGD10139 05 56,00

Cromoflex flexible hose for shower, 1/2"x1/2", 150 cm, conical nut anti-torsion.

Flexible Cromoflex 1/2"x1/2", 150 cm, écrou anti-torsion conique.

Flexschlauch Cromoflex, 1/2"x1/2", 150 cm, konische Überwurfmutter Anti-Torsion.

Flex. Cromoflex 1/2"x1/2", cm 150, tuerca anti-torsión cónica.

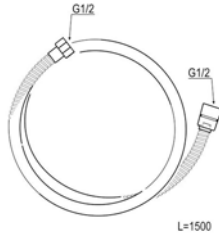

Flessibile in ottone 1/2"x1/2", 150 cm, calotta conica, doppia aggraffatura.

FIGD10182 05 25,00

Flexible hose double clamping 1/2" x 1/2" conical nut.

Flexible double agrafage 1/2" x 1/2" FF conique.

Flexschlauch Doppelverklebung 1/2" x 1/2", konische Muttern an beiden Enden.

Flexible doble engatillado 1/2" x 1/2" FF cónico.

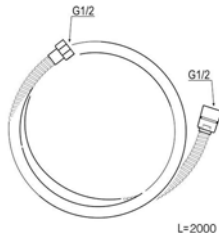

Flessibile in ottone 1/2"x1/2", 200 cm, calotta conica, doppia aggraffatura.

FIGD10163 05 32,00

Double clamping brass flexible hose pipe hose for shower, 1/2"x1/2", 2000 mm, conical nut.

Flexible en laiton 1/2"x1/2", 2000 mm, écrou conique, double agrafage.

Messing flex. Schlauch, 1/2"x1/2", 2000 mm, konische Überwurfmutter, schwere Ausführung.

Flexo en latón 1/2"x1/2", 2000 mm, tuerca conica, doble engatillado.



Flessibile in ottone, 150 cm, doppia aggraffatura, per doccia estraibile.

FIGD10143 05 27,00

Double clamp brass flexible hose for pull-out shower, 120 cm.

Flexible en laiton, 120 cm, double agrafage, pour douchette extractible.

Flexschlauch aus Messing, 120 cm, Doppelverklemmung, für herausziehbare Brause.

Flex. en latón, cm 120, doble engatillado, para ducha extraíble.



Flessibile nylon grigio M15x1, girevole, calotta conica 1/2", 150 cm, con peso.

FIGD10720 05 20,00

Flexible hose nylon grey M15x1, swivel, conical nut 1/2", 1500 mm, with weight.

Flexible en nylon gris M15x1, mobile, calotte conique 1/2", 150 cm, avec poids.

Flexschlauch Nylon grau M15x1, drehbar, Überwurfmutter 1/2", 1500 mm, mit Gewicht.

Flex. nylon gris M15x1, giratorio, tapa cónica 1/2", 1500 mm, con peso.



Flessibile in nylon, 120 cm, per parrucchiere.

FIGD10112 17,00

Nylon flexible hose for pull-out shower, 120 cm.

Flexible en nylon, 120 cm, pour douchette coiffer.

Flexschlauch aus Nylon, 120 cm, für herausziehbare Brause.

Flex. en nylon, cm 120, para peluquero.

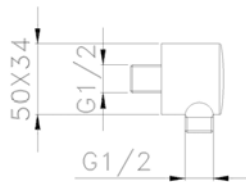

Presca acqua a parete 1/2"x1/2".

FIGD10452 05 49,00

Water supply wall connection, 1/2"x1/2".

Prise d'eau murale 1/2"x1/2".

Wand-Wasseranschluss 1/2"x1/2".

Toma de agua a pared 1/2"x1/2".

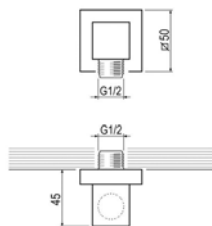

Presca acqua a parete 1/2"x1/2".

FIGD10446 05 54,00

Water supply wall connection, 1/2"x1/2".

Prise d'eau murale 1/2"x1/2".

Wand-Wasseranschluss 1/2"x1/2".

Toma de agua a pared 1/2"x1/2".

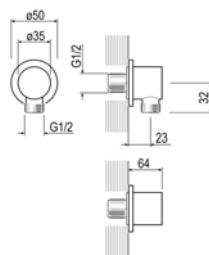

Presca acqua a parete 1/2"x1/2" in ottone.

FIGD10431 05 35,00

Water supply wall connection 1/2"x1/2", brass.

Prise d'eau murale 1/2"x1/2" en laiton.

Wand-Wasseranschluss 1/2"x1/2" in Messing.

Toma de agua para pared 1/2"x1/2" en latón.

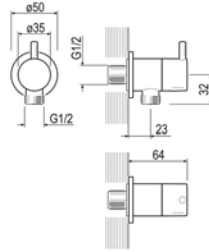

Presă apă a perețe 1/2"x1/2" în otone, cu închisură.

Water supply wall connection 1/2"x1/2", brass, with closure.

Prise d'eau murale 1/2"x1/2" en laiton, avec fermeture.

Wand-Wasseranschluss 1/2"x1/2" in Messing, mit Absperrventil.

Toma de apă a perețe 1/2"x1/2" en latón, con cierre.

FIGD10543 05 72,00

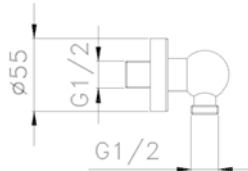

Presă apă a perețe 1/2"x1/2" în otone.

Water supply wall connection 1/2"x1/2", brass.

Prise d'eau murale 1/2"x1/2" en laiton.

Wand-Wasseranschluss 1/2"x1/2" in Messing.

Toma de apă a perețe 1/2"x1/2" en latón.

FIGD10441 05 40,00

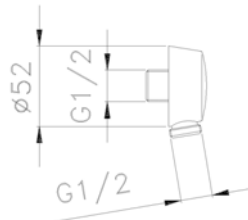

Presă apă a perețe 1/2"M, atac flexibil 1/2", în otone.

Wall mounted water supply 1/2" male, connection flexible hose 1/2", brass.

Prise d'eau murale 1/2"M, raccord flex. 1/2", en laiton.

Wand-Wasseranschluss 1/2" Gewinde, Schlauchanschluss 1/2", in Messing.

Toma de apă a perețe 1/2"M, racor flex. 1/2", en latón.

FIGD10402 05 21,00