

GUGLIELMI®



Regina Plus®



FIRB02503

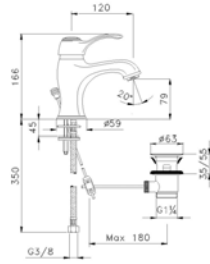

Miscelatore monocomando per lavabo, areatore M24x1, comando scarico 1"¼, flex di alimentazione 3/8".

Single lever washbasin mixer, areator M24x1, 1"¼ pop-up waste, connection flexible hose 3/8".

Mitigeur lavabo, aérateur M24x1, vidage 1"¼, flex d'alimentation 3/8".

Waschtisch-Einhebelmischer, Perlator M24x1, Ablaufgarnitur 1"¼, flexibler Anschluss Schlauch 3/8".

Mezclador monomando para lavabo, aireador M24x1, desagüe 1"¼, flex. de alimentación 3/8".

FBRP18500	05	177,00
FBRP18500	0559	222,00
FBRP18500	TR	240,00



FIRB02503

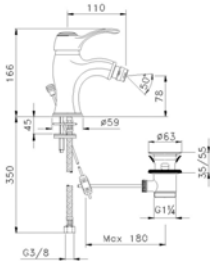

Miscelatore monocomando per bidet, getto orientabile, areatore M24x1, comando scarico 1"¼, flex di alimentazione 3/8".

Single lever bidet mixer, adjustable jet, areator M24x1, 1"¼ pop-up waste, connection flexible hose 3/8".

Mitigeur bidet, jet orientable, aérateur M24x1, vidage 1"¼, flex d'alimentation 3/8".

Bidet-Einhebelmischer, verstellbarer Strahl, Perlator M24x1, Ablaufgarnitur 1"¼, flexibler Anschluss Schlauch 3/8".

Mezclador monomando para bidé, flujo orientable, aireador M24x1, desagüe 1"¼, flex. de alimentación 3/8".

FCRP18550	05	177,00
FCRP18550	0559	222,00
FCRP18550	TR	240,00



FIRB02503

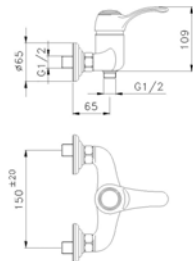

Miscelatore monocomando per doccia esterno, attacco doccia ½".

Single lever wall mounted shower mixer, ½" shower outlet.

Mitigeur douche extérieur, raccord douche ½".

Brausen-Einhebelmischer Aufputz, Schlauchanschluss ½".

Mezclador monomando exterior para ducha, racor ½".

FFRP18800	05	141,00
FFRP18800	0559	176,00
FFRP18800	TR	191,00



FIRB02503

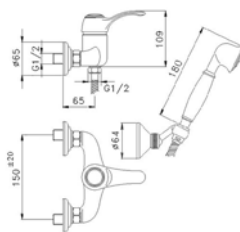

Miscelatore monocomando per doccia esterno, doccia monogetto, supporto orientabile, flessibile 150 cm.

Single lever wall mounted shower mixer, single-jet handshower, adjustable bracket, 150 cm flexible shower hose.

Mitigeur douche extérieur, douchette monojet, support douche orientable, flexible cm 150.

Brausen-Einhebelmischer Aufputz, 1-Strahl Handbrause, verstellbarer Brausehalter, Flexschlauch 150 cm.

Mezclador monomando exterior para ducha, ducha monochorro, soporte orientable, flex. cm 150.

FFRP18830	05	213,00
FFRP18830	0559	266,00
FFRP18830	TR	287,00



FIRB02503

Miscelatore monocomando per doccia esterno, saliscendi regolabile completo di doccia monogetto, supporto orientabile, flessibile 150 cm.

Single lever wall mounted shower mixer, adjustable sliding rail complete of single-jet handshower, adjustable bracket, 150 cm flexible shower hose.

Mitigeur douche extérieur, douchette monojet, support orientable, flexible 150 cm.

Brausen-Einhebelmischer Aufputz, verstellbare Brausestange komplett mit 1-Strahl Handbrause, verstellbarer Brausehalter, Flexschlauch 150 cm.

Mezclador monomando exterior para ducha, barra de ducha regulable, ducha monochorro, soporte orientable, flex. cm 150.

FFRP18834	05	337,00
FFRP18834	0559	422,00
FFRP18834	TR	455,00

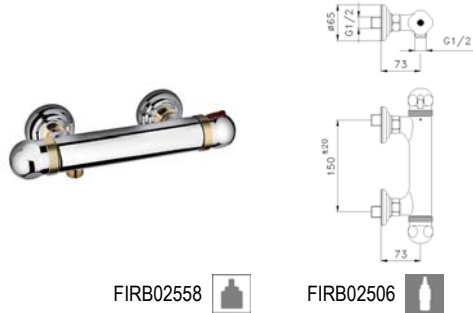

FIRB02558



FIRB02506



Miscelatore termostatico per doccia esterno, con fermo di sicurezza 38° antiscottatura, attacco doccia 1/2".

Thermostatic wall mounted shower mixer, anti-scald safety lock at 38°, 1/2" shower outlet.

Mitigeur douche thermostatique extérieur, arrêt de sécurité 38° antibrûlure, raccord douche 1/2".

Brausen-Thermostatmischer Aufputz, Sicherheitssperre 38° Anti-Verbrühung, Schlauchanschluss 1/2".

Mezclador termostático exterior para ducha, seguro 38° antiquemadura, racor 1/2".

FFTEP0829 05 159,00

FFTEP0829 0559 199,00

FFTEP0829 TR 215,00



10 C

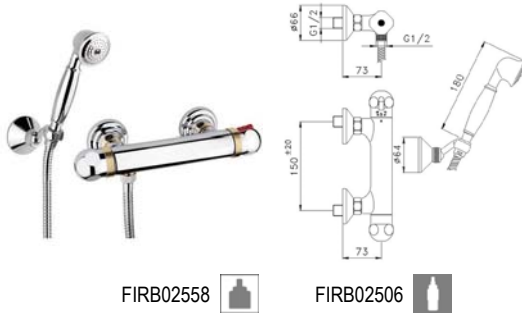

FIRB02558



FIRB02506



Miscelatore termostatico per doccia esterno, con fermo di sicurezza 38° antiscottatura, doccia monogetto, supporto orientabile, flessibile 150 cm.

Thermostatic wall mounted shower mixer, anti-scald safety lock at 38°, single-jet handshower, adjustable bracket, 150 cm flexible shower hose.

Mitigeur douche thermostatique extérieur, arrêt de sécurité 38° antibrûlure, douchette monojet, support orientable, flexible cm 150.

Brausen-Thermostatmischer Aufputz, Sicherheitssperre 38° Anti-Verbrühung, 1-Strahl Handbrause, verstellbarer Brausehalter, Flexschlauch 150 cm.

Mezclador termostático exterior para ducha, seguro 38° antiquemadura, ducha monochorro, soporte orientable, flex. cm 150.

FFTEP0830 05 218,00

FFTEP0830 0559 273,00

FFTEP0830 TR 294,00



10 C



FIRB02558



FIRB02506



Miscelatore termostatico per doccia esterno, con fermo di sicurezza 38° antiscottatura, saliscendi regolabile completo di doccia monogetto, supporto orientabile, flessibile 150 cm.

Thermostatic wall mounted shower mixer, anti-scald safety lock at 38°, adjustable sliding rail complete of single-jet handshower, adjustable bracket, 150 cm flexible shower hose.

Mitigeur douche extérieur thermostatique, arrêt de sécurité 38° antibrûlure, barre murale réglable, douchette monojet, support orientable, flexible cm 150.

Brausen-Thermostatmischer Aufputz, Sicherheitssperre 38° Anti-Verbrühung, verstellbare Brausestange komplett mit 1-Strahl Handbrause, verstellbarer Brausehalter, Flexschlauch 150 cm.

Mezclador termostático exterior para ducha, seguro 38° antiquemadura, barra de ducha regulable, ducha monochorro, soporte orientable, flex. cm 150.

FFTEP0831 05 354,00

FFTEP0831 0559 443,00

FFTEP0831 TR 479,00

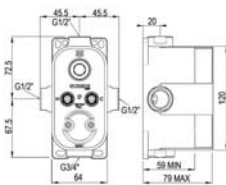

JOLLY BOX, corpo incasso universale miscelatore per vasca doccia, monocomando o termostatico, con antirumore e antiumidità, chiusura acqua calda e fredda in entrata con filtri ispezionabili, attacco 1/2"x3/4".

JOLLY BOX, universal concealed part for bath shower mixer, single lever or thermostatic, antinoise and antihumidity, double stop cock with inspectable filter for hot and cold water, 1/2"x3/4" connection.

JOLLY BOX, corps à encaster universel pour mitigeur bain/douche, monocommande ou thermostatique, antibruit et antihumidité, fermeture eau chaude et froide en entrée avec filtres inspectationnables, raccord 1/2"x3/4".

JOLLY BOX, Universalkörper Unterputz für Wanne/Brause, Einhebel- oder Thermostatmischer, Anti-Lärm und Anti-Feuchtigkeit, Absperrventil mit inspizierbaren Filter für Kalt- und Warmwasser, Anschluss 1/2"x3/4".

JOLLY BOX, cuerpo empotrado universal para mezclador para baño/ducha, monomando o termostático, antiruido y antihumedad, cierre agua caliente y fría en entrada con filtros inspeccionables, racor 1/2"x3/4".

FIIN00667 93,00



12 B

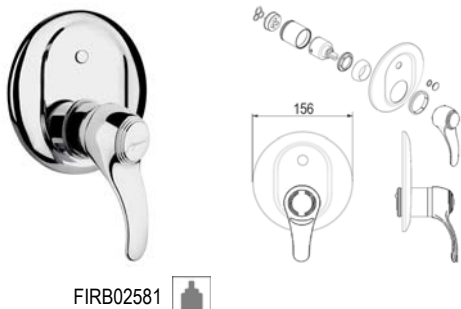

FIRB02581



Parte esterna per monocomando da incasso per doccia, completa di miscelatore, da abbinare solo con JOLLY BOX.

External part for single lever shower mixer, complete of mixer, to be used with JOLLY BOX only.

Partie extérieure pour mitigeur douche à encaster, avec mitigeur, compatible seulement avec JOLLY BOX.

Fertigset für Brausen-Einhebelmischer Unterputz, komplett mit Mischer, in Kombination nur mit JOLLY BOX.

Parte exterior para monomando empotrado para ducha, completa de mezclador, para combinar sólo con JOLLY BOX.

FIIN00758 05 98,00

FIIN00758 0559 122,00

FIIN00758 TR 132,00



FIRB02581

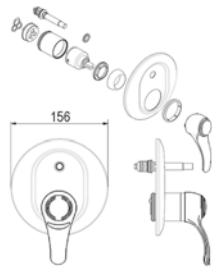

Parte esterna per monocomando da incasso per vasca doccia, completa di miscelatore e deviatore automatico, da abbinare solo con JOLLY BOX.

External part for single lever bath shower mixer, complete of mixer and automatic diverter, to be used with JOLLY BOX only.

Partie extérieure pour mitigeur bain/douche à encastrer, avec mitigeur et inverseur automatique, compatible seulement avec JOLLY BOX.

Fertigset für Wannen/Brausen-Einhebelmischer Unterputz, komplett mit Mischer und automatischem Umsteller, in Kombination nur mit JOLLY BOX.

Parte exterior para monomando empotrado para baño/ducha, completa de mezclador y desviador automático, para combinar sólo con JOLLY BOX.

FIIN00757	05	130,00
FIIN00757	0559	162,00
FIIN00757	TR	174,00



FIRB02579

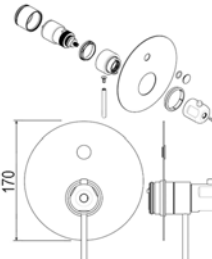

Parte esterna per termostatico da incasso per doccia, completa di miscelatore, da abbinare solo con JOLLY BOX.

External part for thermostatic shower mixer, complete of mixer, to be used with JOLLY BOX only.

Partie extérieure pour mitigeur douche thermostatique à encastrer, avec mitigeur, compatible seulement avec JOLLY BOX.

Fertigset für Brausen-Thermostatmischer Unterputz, komplett mit Mischer, in Kombination nur mit JOLLY BOX.

Parte exterior para termostático empotrado para ducha, completa de mezclador, para combinar sólo con JOLLY BOX.

FIIN00689	05	181,00
FIIN00689	0559	226,00
FIIN00689	TR	244,00



FIRB02579

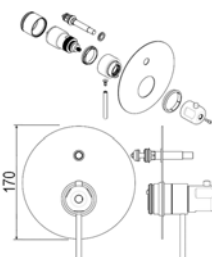

Parte esterna per termostatico da incasso per vasca doccia, completa di miscelatore e deviatore automatico, da abbinare solo con JOLLY BOX.

External part for thermostatic bath shower mixer, complete of mixer and automatic diverter, to be used with JOLLY BOX only.

Partie extérieure pour mitigeur bain/douche thermostatique à encastrer, avec mitigeur et inverseur automatique, compatible seulement avec JOLLY BOX.

Fertigset für Wannen/Brausen-Thermostatmischer Unterputz, komplett mit Mischer und automatischem Umsteller, in Kombination nur mit JOLLY BOX.

Parte exterior para mezclador termostático empotrado para baño/ducha, completa de mezclador y desviador automático, para combinar sólo con JOLLY BOX.

FIIN00688	05	213,00
FIIN00688	0559	266,00
FIIN00688	TR	288,00



FIRB02503

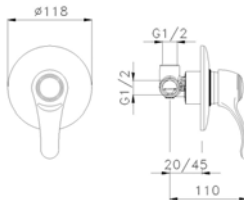

Miscelatore monocomando per doccia incasso, attacco 1/2", completo di parte incasso.

Single lever built-in shower mixer, 1/2" connection, complete of concealed part.

Mitigeur douche à encastrer, raccord 1/2", complet de partie encastrée.

Brausen-Einhebelmischer Unterputz, Anschluss 1/2", komplett mit Grundkörper.

Mezclador empotrado para ducha, racor 1/2", completo de parte empotrada.

FDRP18950	05	93,00
FDRP18950	0559	117,00
FDRP18950	TR	125,00



FIRB02503

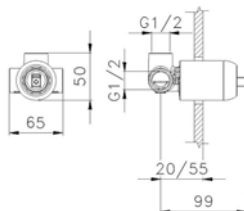

Corpo incasso miscelatore monocomando per doccia ad una uscita, attacco 1/2".

Concealed part for single lever built-in shower mixer 1-way, 1/2" connection.

Corps à encastrer pour mitigeur douche, une sortie, raccord 1/2".

Grundkörper für Brausen-Einhebelmischer Unterputz 1-Weg, Anschluss 1/2".

Cuerpo empotrado para mezclador monomando para ducha, una salida, racor 1/2".

FIIN00416	05	56,00
FIIN00416	0559	71,00
FIIN00416	TR	77,00



Parte esterna per miscelatore monocomando da incasso per doccia.

External part for single lever shower mixer.

Partie extérieure pour mitigeur douche à encastrer.

Fertigset für Brausen-Einhebelmischer Unterputz.

Parte exterior para mezclador monomando empotrado para ducha.

FIIN01105	05	37,00
FIIN01105	0559	46,00
FIIN01105	TR	48,00



FIRB02503

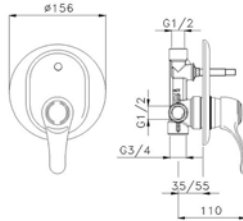

Miscelatore monocomando per vasca doccia incasso, deviatore automatico, completo di parte incasso.

Single lever built-in bath shower mixer, automatic diverter, complete of concealed part.

Mitigeur bain/douche à encastrer, inverseur automatique, complet de partie encastrée.

Wannen/Brausen-Einhebelmischer Unterputz, automatischer Umsteller, komplett mit Grundkörper.

Mezclador monomando empotrado para baño/ducha, desviador automático, completo de parte empotrada.

FDRP18970	05	167,00
FDRP18970	0559	208,00
FDRP18970	TR	224,00



12 C



FIRB02503

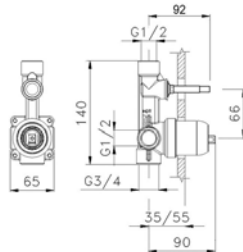

Corpo incasso miscelatore monocomando per vasca/doccia, attacco 1/2"x3/4", con deviatore automatico.

Concealed part for single lever built-in bath shower mixer, 1/2"x3/4" connection, automatic diverter.

Corps à encastrer pour mitigeur bain/douche, raccord 1/2"x3/4", inverseur automatique.

Grundkörper für Wannen/Brausen-Einhebelmischer Unterputz, Anschluss 1/2"x3/4", automatischer Umsteller.

Cuerpo empotrado para mezclador monomando para baño/ducha, racor 1/2"x3/4", desviador automático.

FIIN00417	05	99,00
FIIN00417	0559	124,00
FIIN00417	TR	134,00



12 C



FIRB02503

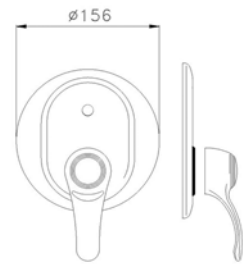

Parte esterna per miscelatore monocomando da incasso per vasca/doccia.

External part for single lever bath shower mixer.

Partie extérieure pour mitigeur bain/douche à encastrer.

Fertigset für Wannen/Brausen-Einhebelmischer Unterputz.

Parte exterior para mezclador monomando empotrado para baño/ducha.

FIIN01106	05	68,00
FIIN01106	0559	84,00
FIIN01106	TR	90,00



FIRB02503

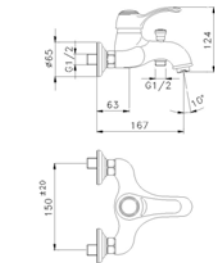

Miscelatore monocomando per vasca esterno, deviatore automatico, areatore M28x1, attacco doccia 1/2".

Single lever bath mixer, automatic diverter, areator M28x1, 1/2" shower outlet.

Mitigeur bain extérieur, inverseur automatique, aérateur M28x1, raccord douche 1/2".

Wannen-Einhebelmischer Aufputz, automatischer Umsteller, Perlator M28x1, Schlauchanschluss 1/2".

Mezclador monomando exterior para baño/ducha, desviador automático, aireador M28x1, racor 1/2".

FARP18599	05	199,00
FARP18599	0559	249,00
FARP18599	TR	270,00



10 A



FIRB02503

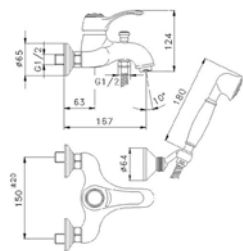

Miscelatore monocomando per vasca esterno, deviatore automatico, areatore M28x1, doccia monogetto, supporto orientabile, flessibile 150 cm.

Single lever bath mixer, automatic diverter, areator M28x1, single-jet handshower, adjustable bracket, 150 cm flexible shower hose.

Mitigeur bain extérieur, inverseur automatique, aérateur M28x1, douchette monojet, support douche réglable, flexible cm 150.

Wannen-Einhebelmischer Aufputz, automatischer Umsteller, Perlator M28x1, 1-Strahl Handbrause, verstellbarer Brausehalter, Flexschlauch 150 cm.

Mezclador monomando exterior para baño/ducha, desviador automático, aireador M28x1, ducha monochorro, soporte orientable, flex. cm 150.

FARP18630	05	270,00
FARP18630	0559	337,00
FARP18630	TR	364,00



10 A



FIRB02558

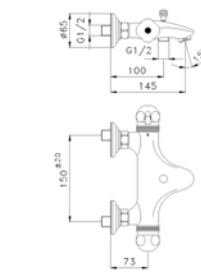

Miscelatore termostatico per vasca esterno, con fermo di sicurezza a 38° anticottatura, deviatore automatico, areatore M24x1, attacco doccia 1/2".

Thermostatic wall mounted bath mixer, anti-scald safety lock at 38°, automatic diverter, areator M24x1, 1/2" shower outlet.

Mitigeur thermostatique extérieur pour bain, arrêt de sécurité à 38° antibrûlure, inverseur automatique, aérateur M24x1, raccord douche 1/2".

Wannen-Thermostatmischer Aufputz, Sicherheitssperre 38° Anti-Verbrühung, automatischer Umsteller, Perlator M24x1, Schlauchanschluss 1/2".

Mezclador termostático exterior para baño/ducha, seguro 38° antiquemadura, desviador automático, aireador M24x1, racor 1/2".

FATEP0799	05	184,00
FATEP0799	0559	230,00
FATEP0799	TR	248,00



7 C



FIRB02558

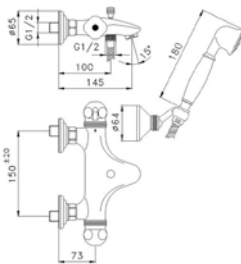

FIRB02506



Miscelatore termostatico per vasca esterno, con fermo di sicurezza a 38° antiscottatura, deviatore automatico, areatore M24x1, doccia monogetto, supporto fisso, flessibile 150 cm.

Thermostatic wall mounted bath mixer, anti-scald safety lock at 38°, automatic diverter, areator M24x1, single-jet handshower, fixed bracket, 150 cm flexible shower hose.

Mitigeur thermostatique extérieur pour bain, arrêt de sécurité à 38° antibrûlure, inverseur automatique, aérateur M24x1, douche monojet, support fix, flexible cm 150.

Wannen-Thermostatmischer Aufputz, Sicherheitssperre 38° Anti-Verbrühung, automatischer Umsteller, Perlator M24x1, 1-Strahl Handbrause, fixer Brausehalter, Flexschlauch 150 cm.

Mezclador termostático exterior para baño/ducha, seguro 38° antiquemadura, desviador automático, aireador M24x1, ducha monochorro, soporte fijo, flex. cm 150.

CODICE	FINITURA	EURO
FATEP0800	05	242,00
FATEP0800	0559	303,00
FATEP0800	TR	327,00



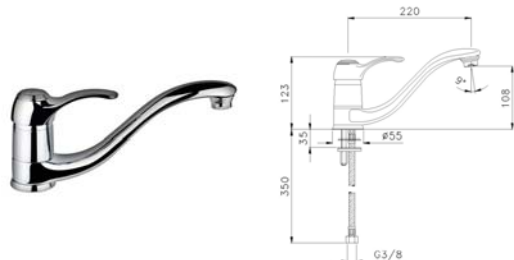

FIRB02504



Miscelatore monocomando per lavello, con bocca fusa girevole, areatore M24x1, flex di alimentazione 3/8".

Single lever sink mixer, casted swivel spout, areator M24x1, connection flexible hose 3/8".

Mitigeur évier, bec coulé mobile, aérateur M24x1, flex d'alimentation 3/8".

Spülen-Einhebelmischer, schwenkbarer Gussauslauf, Perlator M24x1, flexibler Anschluss Schlauch 3/8".

Monomando para fregadero, cuerpo fundido giratorio, aireador M24x1, conexiones de 3/8".

FGRP18908	05	168,00
-----------	----	--------

FGRP18908	0559	211,00
-----------	------	--------

FGRP18908	TR	227,00
-----------	----	--------

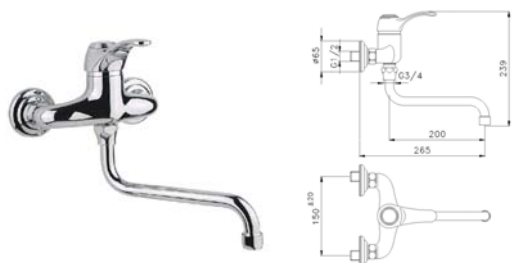

FIRB02503



Miscelatore monocomando per lavello parete, con bocca girevole, areatore M22x1.

Single lever wall mounted sink mixer, swivel spout, areator M22x1.

Mitigeur évier mural, bec mobile, aérateur M22x1.

Spülen-Wand-Einhebelmischer, Schwenkauslauf, Perlator M22x1.

Monomando a pared para fregadero, cuerpo giratorio, aireador M22x1.

FERP18700	05	173,00
-----------	----	--------

FERP18700	0559	217,00
-----------	------	--------

FERP18700	TR	234,00
-----------	----	--------

